

4x4 HDMI Matrix with Analog Audio Outputs  
**B-660-MTRX-4X4**

**BINARY**

INSTALLATION  
MANUAL





## IMPORTANT SAFETY INSTRUCTIONS

To reduce the risk of fire or electric shock, read and follow all instructions and warnings in this manual. Keep this manual for future reference.

1. Do not expose this apparatus to rain or moisture. Do not expose this equipment to dripping or splashing, and ensure that no objects filled with liquids, such as vases, are placed on the equipment.
2. Do not use this apparatus near water.
3. Do not remove cover. No user serviceable parts inside.
4. Clean only with a dry cloth.
5. Do not block any ventilation openings. Install according to manufacturer's instructions.
6. Do not install near any heat sources such as radiators, heat registers, stoves or other apparatus (including amplifiers) that produce heat.
7. Do not override the safety purpose of the polarized or grounding plug. A polarized plug has two blades, one of which is wider than the other. A grounding plug has two matching blades and a third grounding prong. The wide blade or the third prong is provided for your safety. If the provided plug does not fit into your outlet, consult an electrician for replacement of the obsolete outlet.
8. Protect the power cord from being walked on or pinched, particularly at the plug end and where the power cord is attached to the apparatus.
9. Only use attachments and accessories specified by the manufacturer.
10. Refer all servicing to qualified service personnel. Servicing is required when the apparatus has been damaged in any way, such as when the power supply cord or plug is damaged, liquid has been spilled on or objects have fallen into the apparatus, the apparatus has been exposed to rain or moisture, the apparatus does not operate normally, or it has been dropped.
11. To completely disconnect this equipment from power, disconnect the power supply cord from the power outlet.
12. Electrical Disconnect: The source power outlet and power supply input power sockets should be easily accessible to disconnect power in the event of an electrical hazard or malfunction.
13. By means of a power cord connected to a socket-outlet with earthing connection.



The lightning flash with arrowhead symbol, within an equilateral triangle, is intended to alert the user to the presence of uninsulated dangerous voltage within the product's enclosure that may be of sufficient magnitude to constitute a risk of electric shock to persons.



The exclamation point within an equilateral triangle is intended to alert the user to the presence of important operating and maintenance (servicing) instructions in the literature accompanying the appliance.



## LES CONSIGNES DE SÉCURITÉ IMPORTANTES

Pour réduire le risque d'incendie ou de choc électrique, lisez et suivez toutes les instructions et avertissements de ce manuel. Conservez ce manuel pour référence future.

1. N'exposez pas cet appareil à la pluie ou à l'humidité. Cet appareil ne doit pas être exposé à des éclaboussures ou des gouttes d'eau et aucun objet rempli de liquide comme un vase ne doit se trouver à proximité.
2. Ne pas utiliser cet appareil près de l'eau.
3. Ne retirez pas le couvercle. Aucune pièce réparable par l'utilisateur à l'intérieur.
4. Nettoyez l'appareil à l'aide d'un chiffon sec.
5. N'installez pas cet appareil dans un emplacement fermé tel qu'une bibliothèque ou un rack, sauf si cette installation bénéficie d'une aération adaptée.
6. N'installez pas cet appareil à proximité de sources de chaleur, comme des radiateurs, chaudières, fours ou tout autre appareil (comme des amplificateurs) qui dégagent de la chaleur. Ne jamais placer d'objets enflammés, tels que des bougies allumées, sur l'appareil.
7. Ne modifiez pas la fonction de sécurité de la fiche ou de la masse polarisée avec un cordon d'alimentation non connecté à une prise de courant avec une connexion à la terre.
8. Protéger le câble d'alimentation pour qu'il ne soit pas piétiné, coincé ou subisse d'autres dommages.
9. Utilisez uniquement les fixations et accessoires spécifiés par le fabricant.
10. Contactez toutes les interventions de dépannage à un personnel technique qualifié.
11. Débranchez cet appareil pendant les orages ou au cours des longues périodes de non-utilisation.
12. La prise de courant source et les prises d'alimentation d'alimentation doivent être facilement accessibles pour débrancher l'alimentation en cas de dysfonctionnement électrique.
13. Au moyen d'un cordon d'alimentation connecté à un socle de prises de courant avec connexion à la terre.



Le flash de foudre avec le symbole de la tête d'arrow, dans un triangle équilatéral, est destiné à alerter l'utilisateur de la présence de tension dangereuse non isolée dans l'enceinte du produit qui peut être d'une ampleur suffisante pour constituer un risque de choc électrique pour les personnes.



Le point d'exclamation dans un triangle équilatéral est destiné à alerter l'utilisateur de la présence importante d'instructions importantes d'opérations et d'entretien (d'entretien) dans la littérature accompagnant l'appareil.



## CAUTION

1. RISK OF EXPLOSION IF BATTERY IS REPLACED BY AN INCORRECT TYPE.
2. Disposal of a battery into fire or a hot oven, or mechanically crushing or cutting of a battery, that can result in an explosion.
3. Leaving a battery in an extremely high temperature surrounding environment that can result in an explosion or the leakage of flammable liquid or gas.
4. A battery subjected to extremely low air pressure that may result in an explosion or the leakage of flammable liquid or gas.

## WARNING

1. Do not ingest the battery, Chemical burn hazard.
2. (The remote control supplied with) This product contains a coin/button cell battery.
3. If the coin/button cell battery is swallowed, It can cause severe internal burns in just 2 hours and can lead to death.
4. Keep new and used batteries away from children. If the battery compartment does not close securely, stop using the product and keep it away from children.
5. If you think batteries might have been swallowed or placed inside any part of the body, seek immediate medical attention.

## ATTENTION

1. RISQUE D'EXPLOSION SI LA BATTERIE EST REMPLACÉE PAR UN TYPE INCORRECT.
2. Élimination d'une batterie dans le feu ou un four chaud, ou écrasement ou coupe mécanique d'une batterie, qui peut entraîner une explosion.
3. Laisser une batterie dans un environnement environnant à température extrêmement élevée qui peut entraîner une explosion ou une fuite de liquide ou de gaz inflammable.
4. Une batterie soumise à une pression atmosphérique extrêmement basse qui peut entraîner une explosion ou une fuite de liquide ou de gaz inflammable.

## AVERTISSEMENT

1. Ne pas ingérer la batterie, risque de brûlure chimique.
2. (La télécommande fournie avec) Ce produit contient une batterie de cellules de pièce/bouton.
3. Si la batterie de la pièce/bouton de cellule est avalée, elle peut causer de graves brûlures internes en seulement 2 heures et peut entraîner la mort.
4. Gardez les piles neuves et usagées loin des enfants. Si le compartiment de la batterie ne se ferme pas de façon sécuritaire, arrêtez d'utiliser le produit et gardez-le à l'écart des enfants.
5. Si vous pensez que des piles ont pu être avalées ou placées à l'intérieur d'une partie quelconque du corps, consultez immédiatement un médecin.

## FCC WARNINGS

This equipment has been tested and found to comply with the limits for a Class B digital device, pursuant to Part 15 of the FCC Rules. These limits are designed to provide reasonable protection against harmful interference in a residential installation. This equipment generates uses and can radiate radio frequency energy and, if not installed and used in accordance with the instructions, may cause harmful interference to radio communications. However, there is no guarantee that interference will not occur in a particular installation. If this equipment does cause harmful interference to radio or television reception, which can be determined by turning the equipment off and on, the user is encouraged to try to correct the interference by one or more of the following measures:

- Reorient or relocate the receiving antenna.
- Increase the separation between the equipment and receiver.
- Connect the equipment into an outlet on a circuit different from that to which the receiver is connected.
- Consult the dealer or an experienced radio/TV technician for help.

Changes or modifications not expressly approved by the party responsible for compliance could void the user's authority to operate the equipment.

## TRADEMARKS

Dolby Digital™, Dolby TrueHD™, and Dolby Atmos™ are registered trademarks of Dolby Laboratories DTS 5.1™, DTS-HD Master Audio™ and DTS:X™ are registered trademarks of DTS, Inc. All other trademarks and registered trademarks are owned by their respective holders.

## CONTENTS

1. Product overview .....	8
2. Features .....	8
3. Package Contents.....	8
4. Device Layout .....	9
4.1. B-660-MTRX-4x4 Front Panel.....	9
4.2. B-660-MTRX-4x4 Rear Panel.....	9
5. Installation & Wiring.....	10
5.1. Installation .....	10
5.2. Wiring.....	11
6. IR Remote Control.....	12
7. RS-232 Control .....	13
8. Web UI Control.....	14
8.1. Get Access to the Web UI.....	14
8.2. Web UI Introduction .....	16
9. Specifications .....	25
9.1. Transmission Distance .....	26
10. Warranty.....	26
11. Support .....	26

## 1. PRODUCT OVERVIEW

The B-660-MTRX-4x4 is a 4K HDR 4x4 HDMI Matrix Switcher and allows up to four Ultra High Definition 4K HDR or 1080p HD inputs to be independently distributed to four Ultra HD displays. Analog audio outputs are also included for 2ch PCM audio de-embedded from each HDMI output allowing for audio to be distributed separately from each HDMI output. This matrix is controllable via IR, RS-232 and LAN using the built in Web UI. An API is available separately for RS-232 and LAN control.

This matrix was designed to be an Ultra HD A/V distribution solution ideal for a variety of applications that include Home Theater, Offices, Schools, Conference Rooms, Hotels, etc. All this contained in a compact chassis that occupies only 1U of rack mount space.

## 2. FEATURES

- 4 HDMI inputs and 4 HDMI outputs
- Inputs and outputs support video resolutions up to 4K@60Hz 4:4:4 8bit and HDCP 2.2
- Supports 4K HDR, HLG & Dolby Vision™
- Fast switching between multiple video sources
- Supports L/R analog audio de-embedding outputs from each HDMI output (2ch PCM Audio only)
- Supports IR, RS-232 and LAN (Telnet API & Web UI) control options
- Supports API command control through RS-232 and Telnet connection

## 3. PACKAGE CONTENTS

- 1 x B-660-MTRX-4x4 Matrix
- 1 x AC Power Cord with US Pins
- 1 x IR Remote
- 2 x Mounting Brackets (with Screws)
- 1 x Installation Manual



## 4. DEVICE LAYOUT

### 4.1. B-660-MTRX-4x4 Front Panel

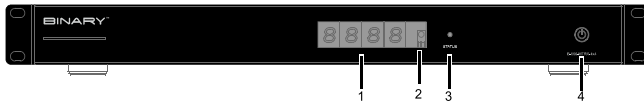

#### 1. Output Channel Indicator

Indicates input for output port 1-4 showing the input related to the output.

#### 2. IR Sensor

Receives IR from handheld IR Remote, IR Emitter, or IR Flasher.

#### 3. STATUS LED

**On:** The device is connected to the network.

**Off:** The device is not connected to the network.

#### 4. Power Switch

Press to power on/off the matrix.

### 4.2. B-660-MTRX-4x4 Rear Panel

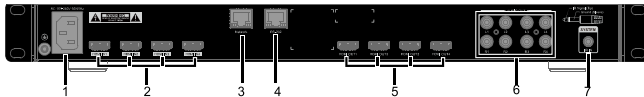

#### 1. AC 100-240V 50/60Hz

Connect the provided power cord. Accepts AC power of 100-240V 50/60Hz.

#### 2. HDMI IN (1-4)

Connect to HDMI Sources.

#### 3. Network

Connect to a control system for Web UI or Telnet control.

#### 4. RS-232

Connect to a control PC or control system for RS-232 serial control.

#### 5. HDMI OUT (1-4)

Connect to an HDMI displays.

#### 6. AUDIO OUT 1-4

For de-embedding 2ch PCM audio to L/R analog audio output. Connect to audio devices via RCA stereo audio cables.

#### 7. IR IN

Connect to the third-party IR control device.

## 5. INSTALLATION & WIRING

### 5.1. Installation

The B-660-MTRX-4x4 occupies 1U space when installed in a standard 19" equipment rack.

#### Steps to Install the Matrix in an Equipment Rack:

1. Attach the Mounting Ears to the enclosure using the screws provided in the package separately.
2. The Mounting Ears are attached to the enclosure as shown.

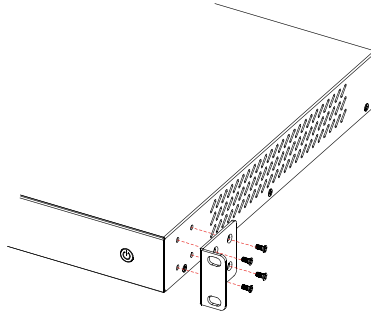

3. Repeat steps 1-2 for the other side of the unit.
4. Mount and affix the unit in the rack with the mounting screws.

## 5.2. Wiring

### Warnings:

- Before beginning any wiring be sure to disconnect the power from all devices in the system.
- During wiring gently connect and disconnect the cables.

### Steps for device wiring:

#### 1. Connect HDMI IN

Connect the HDMI sources (such as PC, Blu-ray player, Apple TV, 4K media player, etc) to the HDMI IN 1-4. Ensure you are using a high-quality HDMI cable capable of supplying the maximum resolution you require.

#### 2. Connect HDMI OUT

Connect the HDMI display device (such as a TV, projector, LED/LCD display or other display device) to the HDMI OUT. Ensure you are using a high-quality HDMI cable capable of supplying the maximum resolution you require.

#### 3. Connect AUDIO OUT

Connect audio devices to AUDIO OUT 1-4 of the Matrix (e.g. audio amplifier) with RCA cables.

#### 4. Connect for additional control options:

- Network Control (Telnet/Web UI): Connect a Local Area Network to the LAN port of the Matrix.
- RS-232 Control: Connect a control PC or control system to RS-232 port of the Matrix.
- IR Control: The IR Remote provided is for controlling the Matrix through IR signal.

#### 5. Connect the provided AC power cord to the Matrix.

#### 6. Power on all attached devices.

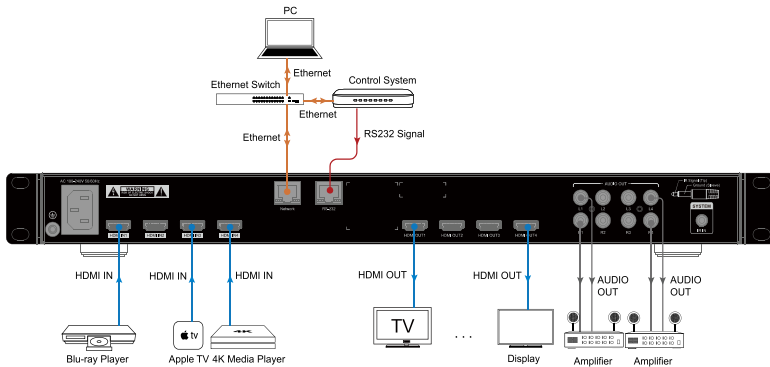

Application Diagram

## 6. IR REMOTE CONTROL

The Matrix can be controlled by the provided IR Remote by pointing it directly at the IR sensor on front panel. This allows for selecting inputs (source) for each output (display) as well as power On and Off for connected CEC-enabled displays.

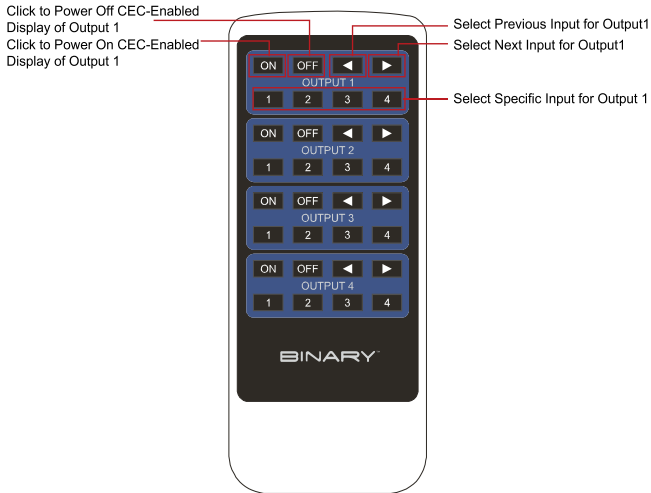

### Assigning Inputs (sources) to Outputs (display):

1. On the remote locate the output to assign an input to, these are in order vertically from top to bottom labeled in the middle of the remote.
2. Press the desired **Input #** or use the **Previous** ◀ or **Next** ▶ button to scroll through the available inputs.

### Virtual IR Code Supported by Default (Matrix Switching Code)

Code	Left (◀)	Right (▶)	In1	In2	In3	In4
Out1	0x57	0x41	0x09	0x1D	0x1F	0x0D
Out2	0x1B	0x11	0x17	0x12	0x59	0x08
Out3	0x55	0x48	0x5E	0x06	0x05	0x03
Out4	0x07	0x40	0x18	0x44	0x0F	0x51

## 7. RS-232 CONTROL

Advanced users may need to control the matrix through RS-232 serial communication. Connect a control PC or control system to the RS-232 port of the receiver. API command for RS-232 control is available in the separate document "API Command Set\_B-660-MTRX-4x4". A professional RS-232 serial interface software (e.g. Serial Assist) may be needed as well.

Before executing the API command through RS-232 serial connection, please ensure RS-232 interface of the device and the control PC are configured correctly.

Parameters	Value
Baud Rate	115200 bps
Data Bits	8 bits
Parity	None
Stop Bits	1 bit
Flow Control	None

### RS-232 Port Connection Pinout

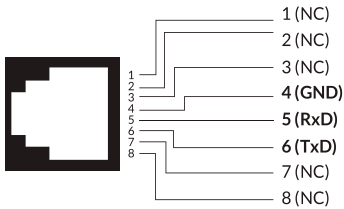

RJ-45	Control Device
4 (GND)	GND
5 (RxD)	TxD (Data Transmit)
6 (TxD)	RxD (Data Receive)

## 8. WEB UI CONTROL

The Web UI designed for the matrix is available for basic controls and advanced settings of the device. The Web UI can be accessed through a browser, e.g. Chrome, Firefox, Safari, Opera, IE, etc..

The default network mode of matrix is DHCP, if there's not a DHCP server, the matrix supports for local IP address.

### 8.1. Get Access to the Web UI

1. Connect the device to the local area network, and connect the PC to the same local area network.
2. Use a tool such as OvrC to identify the IP address of the device or send API command to get IP address (More information, see the separate document "API Command Set\_B-660-MTRX-4x4").
3. Input the IP address in your browser and press Enter. The following window will display.

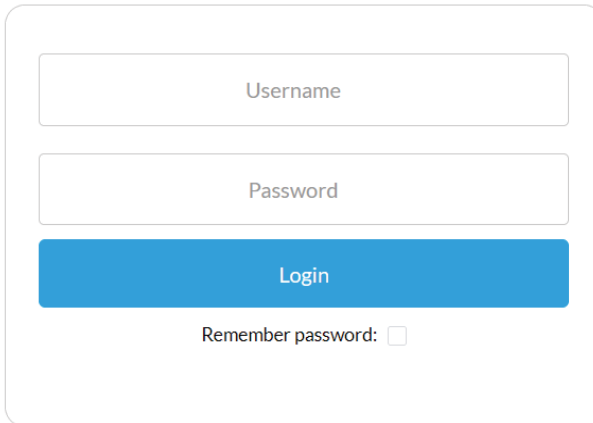

The image shows a login form with a white background and rounded corners. It contains three input fields: a text box for 'Username', a text box for 'Password', and a blue button labeled 'Login'. Below the button is a checkbox labeled 'Remember password:'. The text 'Username' and 'Password' is displayed in a light gray font inside their respective input boxes.

4. Enter the Username and Password. The default username and password are both "binary". Then click "Login". Upon first login the following page will be pop up and require you to change the default username and password.

To proceed, the username and password for this device must be changed. This will also effect the username and password used by control systems to access this device.

**Note:**

- The new username and password must be different from the default used to access the Web UI initially.
- The new username and password must be alphanumeric and between 4 to 16 characters in length.
- Be sure to record the new username and password for accessing the Web UI later.

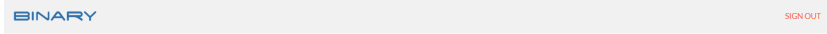

**B-660-MTRX-4x4**



Matrix Control Settings

Matrix Control

INPUT/OUTPUTS	Output 1	Output 2	Output 3	Output 4	All
Input 1	<input checked="" type="checkbox"/>	<input type="checkbox"/>	<input type="checkbox"/>	<input type="checkbox"/>	<input type="checkbox"/>
Input 2	<input type="checkbox"/>	<input checked="" type="checkbox"/>	<input type="checkbox"/>	<input type="checkbox"/>	<input type="checkbox"/>
Input 3	<input type="checkbox"/>	<input type="checkbox"/>	<input checked="" type="checkbox"/>	<input type="checkbox"/>	<input type="checkbox"/>
Input 4	<input type="checkbox"/>	<input type="checkbox"/>	<input type="checkbox"/>	<input checked="" type="checkbox"/>	<input type="checkbox"/>
None	<input type="checkbox"/>	<input type="checkbox"/>	<input type="checkbox"/>	<input type="checkbox"/>	<input type="checkbox"/>

- Presets >
- Input Names >
- Output Names >

## 8.2. Web UI Introduction

The web UI page includes the following submenus: SIGN OUT, FACTORY DEFAULT, UPDATE and REBOOT on the up-right corner, Matrix Control and Settings in the main page.

### 8.2.1. SIGN OUT



Click the icon to return to the login page.

### 8.2.2. FACTORY DEFAULT



After clicking the Factory Default Icon the following window will appear, click "CONFIRM" to reboot the device.

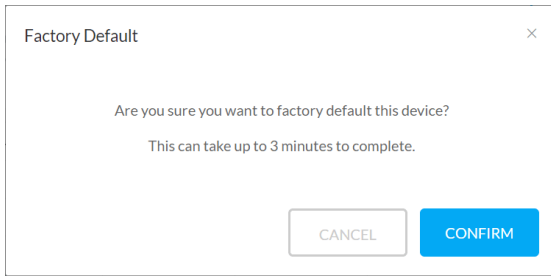

**Note:** Please wait at least 3 minutes to refresh the web page and log in again.



### 8.2.3. UPDATE



After clicking the Update Icon the following window will appear.

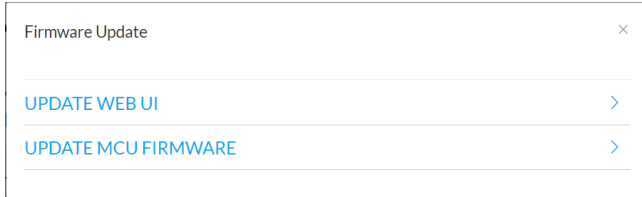

**Note:** When both the MCU and Web UI are being updated the MCU must be updated before the Web UI. This is due to Web UIs requiring specific firmware is installed.

#### MCU Firmware Update:

Click "BROWSE" to select the update bin file, then click "UPDATE" to upgrade the web UI.  
**Example Filename:** MX0404-1018-500-McuUpdate-20200313.tar.gz

Note: Filename shown here is for example purposes only.

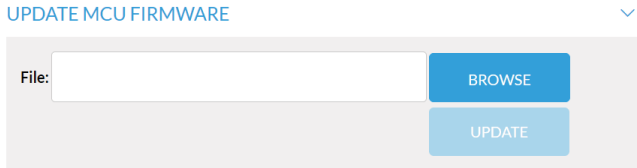

Note: Do not power off the matrix when updating.

**Note:** Do not power off the device when upgrading.

## Web UI Update

Click “BROWSE” to select the update bin file, then click “UPDATE” to upgrade the web UI.

**Example Filename:** MX0404-1018-S00-WebUI-V1.09+dbfe52c6cd3cb6808252179c41d725aa.bin

**Note:** Filename shown here is for example purposes only.

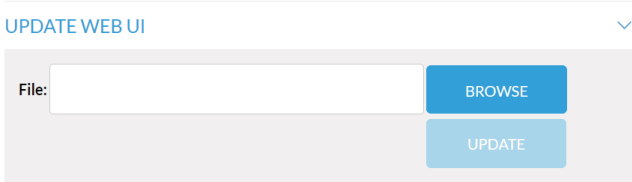

Note:LAN Module will update and reboot automatically. Please wait about 3 minutes, then refresh and login again. Do not power off the matrix when updating.

**Note:** LAN Module will update and reboot automatically, please wait about 3 minutes, then refresh and login again. Don't power off the the matrix when updating.

## 8.2.4. REBOOT



After clicking the Reboot Icon the following window will appear, click “CONFIRM” to reboot the device.

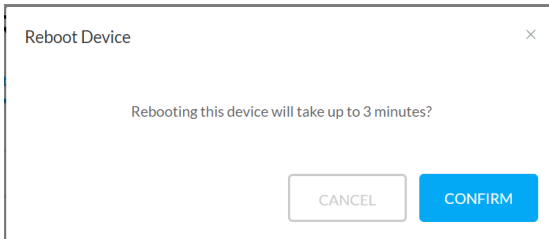

**Note:** Please wait at least 3 minutes to refresh the web page and log in again.

## 8.2.5. Matrix Control

This section includes four submenus: Matrix Control, Presets, Input Names and Output Names.

### 1. Matrix Control

#### Matrix Control

INPUT/OUTPUTS	Output 1	Output 2	Output 3	Output 4	All
Input 1	<input checked="" type="checkbox"/>	<input type="checkbox"/>	<input type="checkbox"/>	<input type="checkbox"/>	<input type="checkbox"/>
Input 2	<input type="checkbox"/>	<input checked="" type="checkbox"/>	<input type="checkbox"/>	<input type="checkbox"/>	<input type="checkbox"/>
Input 3	<input type="checkbox"/>	<input type="checkbox"/>	<input checked="" type="checkbox"/>	<input type="checkbox"/>	<input type="checkbox"/>
Input 4	<input type="checkbox"/>	<input type="checkbox"/>	<input type="checkbox"/>	<input checked="" type="checkbox"/>	<input type="checkbox"/>
None	<input type="checkbox"/>	<input type="checkbox"/>	<input type="checkbox"/>	<input type="checkbox"/>	<input type="checkbox"/>

This section manages distribution of input video sources to output displays. Click the button in the table to select the input for the output display (button turns from grey to blue once selection is done).

- **All Outputs:** Click to route one input to all outputs.
- **None:** None input is routed to the output (or the output is turned off).

By default, Video Input 1 routes to Output 1, ..., Video Input 3 routes to Output 3, Video Input 4 routes to Output 4.

### 2. Presets

#### Presets

Preset 1	Preset 2	Preset 3
<input type="button" value="SAVE"/> <input type="button" value="LOAD"/>	<input type="button" value="SAVE"/> <input type="button" value="LOAD"/>	<input type="button" value="SAVE"/> <input type="button" value="LOAD"/>

This section saves/loads the input/output switch settings to or from the Matrix.

- **SAVE:** Settings in Video Matrix Control section are saved.
- **LOAD:** Preset already saved is loaded.

### 3. Input Names

#### Input Names

Input 1	Input 2	Input 3	Input 4
Input 1	Input 2	Input 3	Input 4

Note: The length of alias name is limited to 15 characters total.

RESET SAVE

This section allows you to redefine input names to identify them by the connected source.

- **SAVE:** Click to save the name change.
- **RESET:** Click to reset the name change.

### 4. Output Names

#### Output Names

Output 1	Output 2	Output 3	Output 4
Output 1	Output 2	Output 3	Output 4

Note: The length of alias name is limited to 15 characters total.

RESET SAVE

This section allows you to redefine input names to identify them by the connected display or zone location.

- **SAVE:** Click to save the name change.
- **RESET:** Click to reset the name change.

**Note:** The length of alias name is limited to 15 characters total.

## 8.2.6. Settings

Settings page includes six submenus: EDID Settings, CEC Control, Login Username, Login Password, Network and Firmware Version.

### 1. EDID Settings

#### EDID Settings

The screenshot shows the EDID Settings interface. At the top, there is an 'Output' dropdown menu currently set to 'HDMI 1' and a blue 'READ' button. Below this, there are four 'Input' sections, each corresponding to an HDMI port (HDMI 1, HDMI 2, HDMI 3, and HDMI 4). Each input section has a dropdown menu set to 'Smart EDID' and a blue 'APPLY' button.

This section allows the EDIDs to be configured for each output based on the requirements of the displays in the system based on the available EDID setting below.

EDID	Operation
SmartEDID (Default)	Reviews the resolutions of all connected displays and sets the EDID to the lowest resolution and/or audio available for all outputs.
EDID Write	Copies the EDID from the display connected to the selected output.
Fixed 4K60 7.1CH Encoded Audio with HDR	Supports up to: 4K60 7.1CH with HDR
Fixed 4K30 2.0CH PCM Audio with SDR	Supports up to: 4K30 2.0CH PCM with SDR
Fixed 1080p@60Hz 7.1CH Encoded Audio with HDR	Supports up to: 1080p@60Hz 7.1CH with HDR
Fixed 1080p@60Hz 5.1CH Encoded Audio with HDR	Supports up to: 1080p@60Hz 5.1CH with HDR
Fixed 1080p@60Hz 2.0CH Audio with HDR	Supports up to: 1080p@60Hz 2.0CH with HDR
Fixed 1080p@60Hz 2.0CH Audio with SDR	Supports up to: 1080p@60Hz 2.0CH with SDR

#### Configuring EDIDs

1. Select the Output port (HDMI 1-4) from Output drop-down menu.
2. Select the EDID setting for each input based on the above table.

**Note:** If EDID copy fails the output will default to 4K@30Hz 2.0ch audio.

## 2. CEC Control

### Note:

- The following commands require that the display is CEC-enabled.
- Auto CEC within the matrix is disabled by default, enable if auto CEC power is required.

### CEC Control

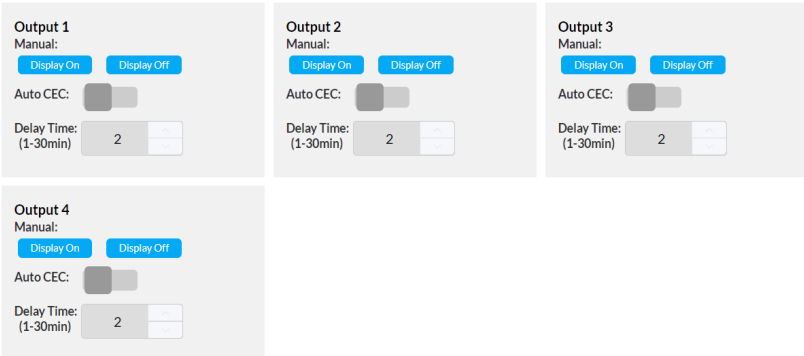

The screenshot displays four separate control panels for CEC outputs, labeled Output 1 through Output 4. Each panel is organized as follows:

- Manual Control:** Two blue buttons labeled "Display On" and "Display Off".
- Auto CEC:** A horizontal slider control, currently positioned to the left, indicating it is disabled.
- Delay Time:** A numeric input field showing "2" with up and down arrows, and the text "(1-30min)" below it.

- **Display On:** Click to power On a connected CEC-enabled display.
- **Display Off:** Click to power Off a connected the CEC-enabled display.
- **Auto CEC Slider:**
  - **Auto:** Select to have the matrix send a power On command to the connected display when the output senses a video signal and send a power Off command once the output senses a loss of video signal. Power on commands are sent within 10secs of detection of signal and delay time for power Off can be set from 1~30mins by changing the values in the Delay Time selector box.
  - **Manual:** Select when manual control of the display will be handled through an outside method such as an IR, RS-232, or IP control system. When manual is selected automatic sensing to send power commands to the display is disabled. Note that there might be a 5~10sec delay for the display to respond when sending the commands manually.
- **Delay Time (1~30min):** Use the up/down arrows to select a delay time from 1~30mins for powering off the display after loss of video signal is detected. Note that this setting has no function when the slider is set to Manual.

### 3. Network

#### Network

MAC Address: D4:6A:91:21:82:B3

DHCP  Static

Device IP Address	DNS Server 1
192.168.20.54	192.168.20.1
Subnet Mask	DNS Server 2
255.255.255.0	192.168.1.1
Device Gateway	
192.168.20.1	

Note: LAN Module will automatically reboot after changing Network setting.

APPLY

Network is used to set between the static and dynamic IP address.

- **DHCP:** When enabled, the IP address of the Matrix is assigned automatically by the DHCP server connected.
- **Static:** When enabled, set up the IP address manually.
- **Apply:** Click to enable the network setting.

#### Note:

- When “Static” is selected, please ensure your PC is in the same network segment as the Matrix, i.e. the IP address of your PC should be set as 192.168.xxx.xxx.
- Please wait for 2-3 minutes for the Matrix’s LAN module to reboot and reconnect after the network setting is changed.

By default, the IP type is set as DHCP. If it doesn't have DHCP server, the matrix supports for local IP address. Use API Command to get the IP address.

## 4. Login Username

### Login Username

Old Username

New Username

Note: Username must be 4 to 16 characters in length, alphanumeric only.

APPLY

This section allows for changing the Login Username to protect against unwanted access to the Web UI.

**Note:** Username must be 4 to 16 characters in length, alphanumeric only.

## 5. Login Password

### Login Password

Old Password

New Password

Confirm New Password

Note: Password must be 4 to 16 characters in length, alphanumeric only.

APPLY

This section allows for changing the Login Password to protect against unwanted access to the Web UI.

**Note:** Password must be 4 to 16 characters in length, alphanumeric only.

## 6. Firmware Version

### Firmware Version

MCU: V1.7

WEB UI: V1.08

This section allows you to obtain information of the current firmware in use.



## 9. SPECIFICATIONS

Technical	
Input/Output Port	4 x HDMI IN, 4 x HDMI OUT 4 x AUDIO OUT (3.5mm analog L/R audio out), 1 x RS-232, 1 x Network, 1 x IR IN, 1 x AC 100-240V 50/60Hz
Input/Output Signal Type	HDMI with 4K@60Hz 4:4:4, HDR, HLG & Dolby Vision, HDCP 2.2
Input/Output Resolution Supported	VESA: 800x600 <sup>8</sup> , 1024x768 <sup>8</sup> , 1280x768 <sup>8</sup> , 1280x800 <sup>8</sup> , 1280x960 <sup>8</sup> , 1280x1024 <sup>8</sup> , 1360x768 <sup>8</sup> , 1366x768 <sup>8</sup> , 1440x900 <sup>8</sup> , 1600x900 <sup>8</sup> , 1600x1200 <sup>8</sup> , 1680x1050 <sup>8</sup> , 1920x1200 <sup>8</sup> SMPTE: 720x576P <sup>6</sup> , 1280x720P <sup>6,7,8</sup> , 1920x1080P <sup>2,5,6,7,8</sup> , 3840x2160 <sup>2,3,5,6,8</sup> , 4096x2160 <sup>2,3,5,6,8</sup> 1 = at 23.98 Hz, 2 = at 24 Hz, 3 = at 25 Hz, 4 = at 29.97 Hz, 5 = at 30 Hz, 6 = at 50 Hz, 7 = at 59.94 Hz, 8 = 60 Hz, 9 = 75 Hz
Audio Format	HDMI IN/OUT: Fully supports audio formats in HDMI 2.0 specification, including PCM 2.0/5.1/7.1, Dolby TrueHD™, Dolby Atmos™, DTS-HD Master Audio™ and DTS:X™ L&R Analog AUDIO OUT: Stereo
Maximum Data Rate	HDMI IN & HDMI OUT: 18Gbps
Control Method	IR, RS-232, CEC, Network Control (Telnet & Web UI)

General	
Operating Temperature	0°C to 40°C (32°F to 104°F)
Storage Temperature	-20°C to 60°C (-4°F to 140°F)
Humidity	10% to 90%, non-condensing
ESD Protection	Human-body Model: ±15kV (Air-gap discharge)
Power Supply	AC 100-240V 50/60Hz
Power Consumption (Max)	26W
Device Dimension (W x H x D)	440mm x 43.5mm x 300mm/17.32" x 1.71" x 11.81" (without mounting brackets)
Product Weight	3.24kg/7.14lb
Rack Space Required	1U

## 9.1. Transmission Distance

Cable Type	Range	Supported Video
HDMI	Input/Output: 15m/49ft	1080P@60Hz 24bpp
	Input: 5m/16ft	4K@60Hz 4:2:0 24bpp with HDR
	Output: 10m/33ft	
	Input: 3m/10ft	4K@60Hz 4:4:4 24bpp with HDR
Output: 5m/16ft		

## 10. WARRANTY

Find details of the product's Limited Warranty and other safety, patent, and legal resources at [snapone.com/legal](https://snapone.com/legal) or request a paper copy from Customer Service at **866.424.4489**

## 11. SUPPORT

For chat and telephone, visit [tech.control4.com/s/contactsupport](https://tech.control4.com/s/contactsupport)

● Email: [TechSupport@SnapOne.com](mailto:TechSupport@SnapOne.com) ● Visit [tech.control4.com](https://tech.control4.com) for discussions, instructional videos, news, and more.



Copyright ©2021, Snap One, LLC. All rights reserved. Snap One and its respective logos are registered trademarks or trademarks of Snap One, LLC (formerly known as Wirepath Home Systems, LLC), in the United States and/or other countries. 4Store, 4Sight, Control4, Control4 My Home, SnapAV, Araknis Networks, BakPak, Binary, Dragonfly, Episode, Luma, Mockupancy, Nearus, NEEO, Optiview, OvrC, Pakedge, Sense, Strong, Strong Evolve, Strong VersaBox, SunBriteDS, SunBriteTV, Triad, Truvision, Visualint, WattBox, Wirepath, and Wirepath ONE are also registered trademarks or trademarks of Snap One, LLC. Other names and brands may be claimed as the property of their respective owners. Snap One makes no claim that the information contained herein covers all installation scenarios and contingencies, or product use risks. Information within this specification subject to change without notice.

**BINARY®**

200-B-660-MTRX-4X4-B