

# Control4® Smart Home Climate and Comfort Guide

SEE THE NEW OS 3 USER GUIDE  
AT [CTRL4.CO/USERGUIDE](http://CTRL4.CO/USERGUIDE)





## Contents

Comfort menu overview . . . . .	2
Using your thermostat . . . . .	3
Changing the temperature . . . . .	3
Changing the humidity . . . . .	3
Creating and using presets . . . . .	4
Setting schedules . . . . .	5
Changing the temperature scale . . . . .	5
Clearing service reminders . . . . .	6
Control4 Wireless Thermostat by Aprilaire . . . . .	7
Controlling blinds and shades . . . . .	8
Legal notices . . . . .	9

**Note:** The information in this guide applies to the latest Control4 system capabilities. Features can vary between customized installations and Control4 software releases, so contact your dealer with any questions about available features.

# Comfort menu overview

Available settings in this menu depend on the HVAC equipment connected to your Control4 system, but these are the possible settings.

 Temperature	 Humidity	 Schedule	 Extras
Control heating and cooling (default view)	Sets humidity levels (if supported)	Create and view schedules	Set C°/F° and specify sensor location

**Mode**  
Choose from Heat, Cool, Auto, and Off.



**Fan**  
Choose from On, Auto, and Circulate.



**Presets**  
Select to display (and configure) your climate presets.



**Hold**  
Select to keep the current climate settings, regardless of presets or schedules.



# Using your thermostat

Whatever thermostat your home uses, Control4 gives you an easy-to-use interface for adjusting the climate. You can control temperature, humidity, and fan settings from your home or on the other side of the planet.

Control4 does more than just provide a pretty face to climate control—it lets you create a variety of set points (temperature ranges) and associate them with schedules or events in your home automation system. For example, you can begin cooling down your house 30 minutes before you come home from work, or it can start automatically whenever you enter the front door.

## Changing the temperature

You can start out by using the climate control the same way you'd use a regular thermostat.

### To change the temperature:

- 1 On a Navigator's home screen, select **Comfort**. The climate controls open.



- 2 Move the orange “heat” set point  or the blue “cool” set point  to the temperature you want.

- OR -



Select the temperature in the center, and adjust set points in the screen that opens.

## Changing the humidity

### To change the humidity:

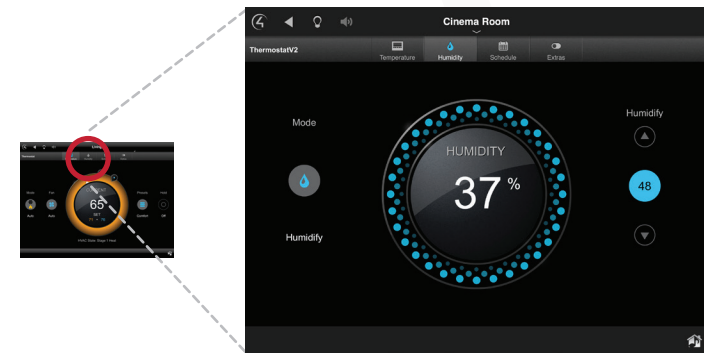
- 1 On a Navigator's home screen, select **Comfort**, then **Humidity**. The humidity controls open.



- 2 Select  or  to adjust the humidity level.
- 3 Select **Mode** to turn Humidify off or on.

## Creating and using presets

*Presets* are a powerful and flexible way to save all of your climate settings, including heat and cool set points, fan mode, and humidity settings. With one touch, you can recall the right settings for any mood or activity, or you can schedule them. Presets make it easy for your home to respond to your life—you are no longer bound to a rigid, time-based schedule.

### To create or edit a preset:

- 1 On a Navigator's home screen, select **Comfort**.
- 2 If your home has multiple thermostats, select the correct one.
- 3 Select **Presets**. The preset list appears, showing your currently available presets (if any).



- 4 To create a new preset, click the **+** or the pencil icon (depending on the type of Navigator) in the upper-right corner. Or, to edit an existing preset, select the preset name.

Here you can select what's contained in your new preset, such as the desired temperature for heating and cooling modes, the fan mode, humidity levels, and more.

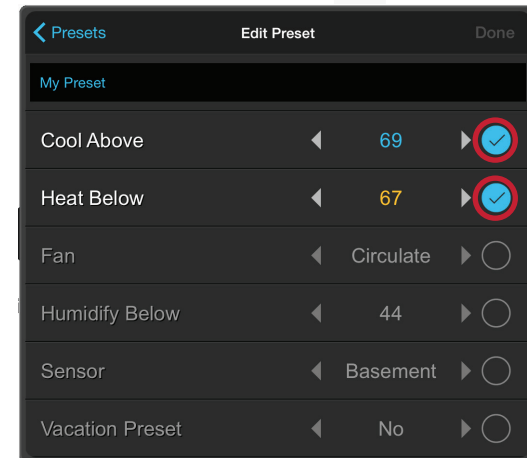

- 5 To name (or rename) the preset, select the blue name field, use the on-screen keyboard to type a name, then select **Done**.
- 6 To change values of the other fields, select ◀ or ▶.
-  **Note:** If **Auto Mode** is enabled on your thermostat, your thermostat will be changed to **Auto Mode** when this preset is selected.
- 7 After you've configured all settings for the preset, select **Done**.

### To use a preset:

- 1 On a Navigator's home screen, select **Comfort** > **Presets** > [Preset Name]
- OR -
- Associate a preset with a schedule. See "Setting schedules" on page 5.

## Setting schedules

A *schedule* is a range of times associated with a climate preset. Creating a schedule is simple after you've created your presets.

### To create or edit a schedule:

- 1 On a Navigator's home screen, select **Comfort**, then select **Schedule**, then select the day of the week to set a schedule for. The daily schedules (if any have been already defined) appear.

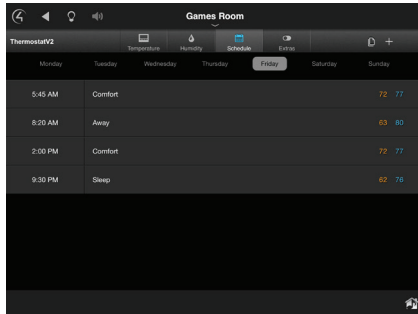

- 2 To add a schedule, select the **+** or the pencil icon (depending on the type of Navigator) in the upper-right corner. Or, to edit an existing schedule, tap the schedule.
- 3 Select **▲** or **▼** to set the start time, then select **Next**. The preset list opens.
- 4 Select the preset you want to use at that time, then press **Done**. Repeat the process for all events for that day.

After creating schedules for a full day, you can copy the schedule to other days and thermostats.

### To copy a day's schedule:

- 1 In the thermostat screen, select **Schedules** and the day to copy *from*.
- 2 Select  (copy).
- 3 Select each day you want to copy the schedule *to* (indicated by check marks).
- 4 If you have multiple thermostats, you can copy the schedule to those thermostats by selecting **Apply to all Thermostats**.

 **Note:** The presets that the schedule uses must be configured on the other thermostats *before* the schedule is copied to them.

- 5 Select **Copy**.

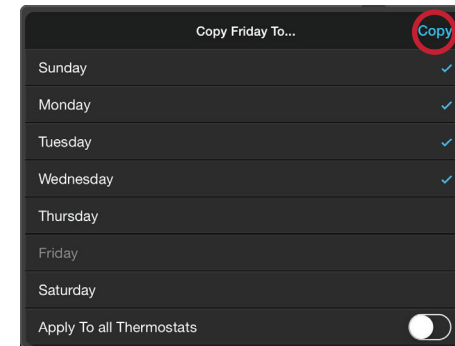

## Changing the temperature scale

### To change the temperature scale:

- 1 On a Navigator's home screen, select **Comfort**. The climate controls open.
- 2 Select *Extras*.
- 3 Select the temperature scale (**Fahrenheit** or **Celsius**).

## Clearing service reminders

Every three months, a message appears on the Comfort control screen to remind you to change your HVAC system's filters.



To dismiss the reminder:

- 1 From the thermostat screen, select **Extras**, then, on the *Reset HVAC Service Reminder* bar, select **Reset**. The message clears.

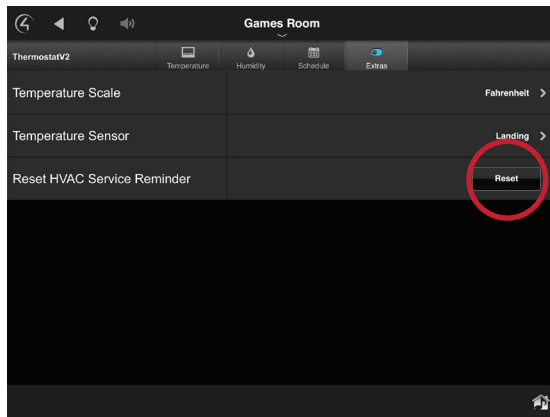

# Control4 Wireless Thermostat by Aprilaire



The Control4 Wireless Thermostat by Aprilaire is a reliable, sophisticated device that consistently delivers the right level of comfort in the most efficient way possible. With advanced presets and scheduling, the thermostat works with you instead of forcing you to fit climate control into a rigid schedule.

- Enhanced compatibility with modern HVAC systems, including forced air, geothermal, dual fuel, and humidity control systems
- Control heating, cooling, ventilation, humidification, and dehumidification (with compatible HVAC systems)
- Easily adjust heat and cool set points, fan control, and humidity mode right at the thermostat
- Backlit LCD displays the temperature, operating mode, and status of HVAC, Indoor Air Quality control, fan, and hold
- Complementary design with Control4 lighting products
- Can easily be mounted in a utility closet with an optional remote temperature sensor

## Learn more

If you have this thermostat installed, you can learn more about its operation in the user guide at [ctrl4.co/tstat-user](http://ctrl4.co/tstat-user).

# Controlling blinds and shades

Along with thermostats, window coverings can affect your home's comfort level. Use Control4 to manage your home's blinds and shades.

 **Tip:** Use blinds and shades to help regulate your home's temperature.

## To control a room's blinds and shades:

- 1 Select the room, if necessary, from the room pull-down menu at the top center of the screen.



- 2 Select the **Shades** icon.

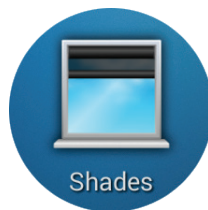

The room's blinds and shades controls open.

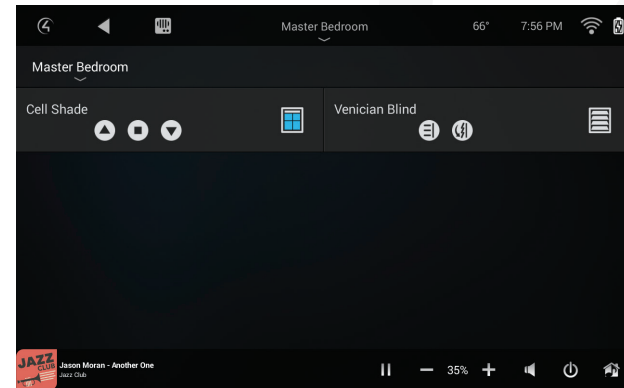

- 3 Select the blind and shade controls to open or close them. It's important to remember that depending on how your blinds are installed, closing the blinds could be done by either raising or lowering them.

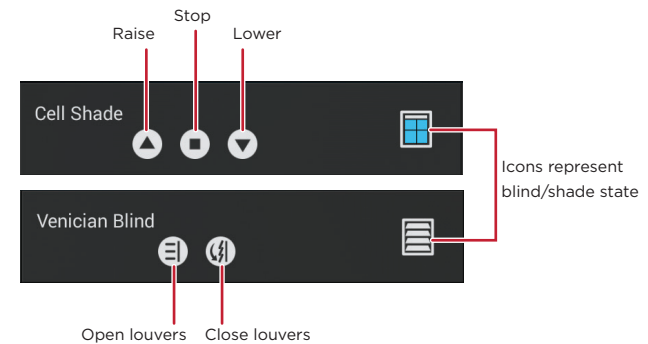



# Legal notices

## Control4 disclaimer

Control4® makes no representations or warranties with respect to this publication, and specifically disclaims any express or implied warranties of merchantability or fitness for any particular purpose. Control4 reserves the right to make changes to any and all parts of this publication at any time, without any obligation to notify any person or entity of such changes.

## GNU

GNU GENERAL PUBLIC LICENSE TERMS AND CONDITIONS FOR COPYING, DISTRIBUTION AND MODIFICATION (Section 3.b.)

You may copy and distribute the Program (or a work based on it, under Section 2) in object code or executable form under the terms of Sections 1 and 2 above provided that you also do one of the following:

Accompany it with a written offer, valid for at least three years, to give any third party, for a charge no more than your cost of physically performing source distribution, a complete machine-readable copy of the corresponding source code, to be distributed under the terms of Sections 1 and 2 on a medium customarily used for software interchange.

The complete text for this license is available on the Control4 web site at: [www.control4.com](http://www.control4.com).

## Gracenote

Gracenote®, Gracenote logo and logotype, and the “Powered by Gracenote” logo are either a registered trademark or a trademark of Gracenote, Inc. in the United States and/or other countries. Music and DVD recognition technology and related data are provided by Gracenote®. Gracenote is the industry standard in Music and DVD recognition technology and related content delivery. For more information visit [www.gracenote.com](http://www.gracenote.com).



control4.com | 888.400.4070

## MPEG

Fraunhofer IIS and Thomson. MPEG Layer-3 audio coding technology licensed from Fraunhofer IIS and Thomson. Supply of this product does not convey a license nor imply any right to distribute content created with this product in revenue-generating broadcast systems (terrestrial, satellite, cable, and /or other distribution channels), streaming applications (via Internet, intranets, and/or other networks), other content distribution systems (pay-audio or audio-on-demand applications, and the like) or on physical media (compact discs, digital versatile discs, semiconductor chips, hard drives, memory cards, and the like). An independent license for such use is required. For details, visit [mp3licensing.com](http://mp3licensing.com). Radio Locator is the service provider of AM/FM channel list.

## Spread

This product uses software developed by Spread Concepts LLC for use in the Spread toolkit. For more information about Spread see [www.spread.org](http://www.spread.org).

## All Media Guide

© 2005-2008 All Media Guide, LLC provides music and video recognition technology that provides cover art and related text that enriches the Control4 user Navigators.

## Copyright and trademarks

Copyright ©2016, Control4 Corporation. All rights reserved. Control4, the Control4 logo, the 4-ball logo, 4Store, 4Sight, Control4 My Home, and Mockupancy are registered trademarks or trademarks of Control4 Corporation in the United States and/or other countries. All other names and brands may be claimed as the property of their respective owners. All specifications subject to change without notice.

No part of this publication may be reproduced, photocopied, stored on a retrieval system, or transmitted without the express written consent of the publisher.

## Contact information

Control4 Corporation  
11734 S. Election Road  
Salt Lake City, UT 84020 USA  
[www.control4.com](http://www.control4.com)

**B**

DOC-00142-B  
2016-08-09 MS