



Keypad Dimmer Installation Guide

Supported models

- C4-KD120 Keypad Dimmer, 120V
- C4-KD277 Keypad Dimmer, 277V

Introduction

The Control4® Keypad Dimmer operates independently or as part of a Control4 home automation system. It installs in a standard back box using typical wiring standards and communicates to the Control4 system using a wireless connection.

Box contents

- Keypad Dimmer
- Keypad Button Kit
- Wire nuts
- Warranty card
- *Keypad Dimmer Installation Guide* (this document)
- *Keypad Button Installation Guide*

Specifications and supported load types

The specifications are described below.

Model numbers	C4-KD120-xx, C4-KD277-xx		
Power requirements	C4-KD120: 120VAC +/-10%, 50/60Hz C4-KD277: 277VAC +/-10%, 50/60Hz This device can function with or without a neutral AC connection depending on load type. Wiring with a neutral is always the preferred wiring method (if possible). See load types and "Sample Wiring Configurations" below. When wired without a neutral, loads may appear dimmer.		
Power consumption	C4-KD120: 786mW; C4-KD277: 2.51W		
Load types and ratings			
Supported load types	Incandescent, halogen, electronic (solid state) low voltage (ELV) transformers, magnetic (iron core, inductive) low voltage (MLV) transformers, phase-dimmable fluorescents, compact fluorescents, and LEDs. Important: Do <i>not</i> use with non-dimmable loads.		
C4-KD120 maximum load	1 Gang	2 Gang	3+ Gang
Incandescent (tungsten)	600W	550W	500W
Halogen	600W	550W	500W
Fluorescent*	300W	300W	300W
Compact fluorescent (CFL)*	300W	300W	300W
LED*	120W	120W	120W

C4-KD277 maximum load	1 Gang	2 Gang	3+ Gang
Incandescent (tungsten)	1000	900	800
Halogen	1000	900	800
Fluorescent*	500	500	500

Compact fluorescent (CFL)*	500	500	500
LED*	200	200	200

Minimum load (with neutral)			
All load types	1W		
Minimum load (without neutral)			
Incandescent (tungsten)	7W		
Halogen	7W		
Fluorescent*	N/A		
Compact fluorescent (CFL)*	N/A		
LED*	N/A		

Environmental	
Operational temperature	32°F - 104°F (0°C - 40°C) All load ratings are based on an ambient temperature of 77°F (25°C).
Humidity	5% to 95% non-condensing
Storage	-4°F - 158°F (-20°C - 70°C)

Miscellaneous	
Control communications	ZigBee, IEEE 802.15.4, 2.4 GHz, 15-channel spread spectrum radio
Wallbox volume	5.75 cubic inches
Weight	0.12 lb. (0.05 kg)
Shipping weight	0.22 lb. (0.10 kg)



* NOTES:

- (1) The maximum load requirements for fluorescent, CFL and LED loads can vary greatly depending upon the specific fixture and/or bulb being used. These load types have significant in-rush current which can trip the protection circuitry on the device.
- (2) The quality and performance of these load types varies greatly from manufacturer to manufacturer. When using these load types, we recommend testing in advance. If problems are found, simply changing to a different bulb manufacturer may solve the problem.
- (3) Additionally, we do not recommend the use of fluorescent, CFL, or LED loads without a neutral wire connected to the dimmer due to the capacitive nature of these load types.
- (4) Wiring with a neutral is always the preferred wiring method (if possible).

Warnings and considerations



WARNING! Turn OFF electrical power before installing or servicing this product. Improper use or installation can cause SERIOUS INJURY, DEATH or LOSS/DAMAGE OF PROPERTY.

ATTENTION! Coupez l'alimentation électrique avant d'installer ou de réparer ce produit. Une mauvaise installation ou utilisation peut entraîner des blessures graves, décès ou perte / dommages à la propriété.



WARNING! This device must be protected by a circuit breaker (20A max).
ATTENTION! Cet appareil doit être protégé par un disjoncteur (20A max.)



WARNING! Ground this device in accordance with the National Electric Code (NEC) requirements. DO NOT rely solely upon the yoke plate's contact with a metal wallbox for adequate grounding. Use the device's ground wire to make a secure connection to the safety ground of the electrical system.

ATTENTION! Cet appareil doit être en conformité avec le Code national de l'électricité (NEC). Ne comptez pas uniquement au contact de la plaque avant avec un boîtier mural métallique pour la mise à la terre adéquate. Utilisez cet appareil à la terre de l'appareil pour établir une connexion sécurisée au système électrique.



IMPORTANT! This device must be installed by a licensed electrician in accordance with all national and local electrical codes.



IMPORTANT! For wiring the dimmer, we recommend always using a neutral wire when possible. See Figure 6.



IMPORTANT! If you are unsure about any part of these instructions, consult a qualified electrician.



IMPORTANT! Use this device only with copper or copper-clad wire. Do not use aluminum wiring. This product has not been approved for use with aluminum wiring.



IMPORTANT! To reduce the risk of overheating and possible damage to other equipment, do not install to control a receptacle or a motor operated appliance.



IMPORTANT! This product generates heat during normal operation.



IMPORTANT! Using this product in a manner other than outlined in this document voids your warranty. Further, Control4 is NOT liable for any damage incurred with the misuse of this product. See "Troubleshooting."



IMPORTANT! Do NOT use a power screwdriver to install this device. If you do, you may overtighten the screws and strip them. Also, overtightening the screws may interfere with proper button operation.



IMPORTANT! This is an electronic device with intricate components. Handle and install with care!



IMPORTANT! Control4 does not guarantee the performance of any bulb or lamp/fixture in your environment. CUSTOMER ASSUMES ALL RISKS, INCLUDING ANY DAMAGE TO CONTROL4 PRODUCTS, ASSOCIATED WITH (i) THE TYPE, LOAD RATING AND QUALITY OF THE BULB AND LAMP/FIXTURE, OR (ii) ANY USE OR INSTALLATION NOT IN ACCORDANCE WITH THE DOCUMENTATION FURNISHED BY CONTROL4, EITHER WITH THE CONTROL4 PRODUCT OR AT WWW.CONTROL4.COM.



IMPORTANT! When used in conjunction with an Auxiliary Keypad (C4-KA-xx), the wire connecting the Auxiliary Keypad to the dimmer must not exceed 150 feet (45 m) at 120VAC, and 100 feet (30 m) at 277VAC.

Installation instructions

- 1 Ensure that the location and intended use meet the following criteria:
 - Do not exceed the load capacity requirements of the dimmer. In multi-gang installations, a reduction of the dimmers' capacity is required to allow the dimmers to be installed side-by-side. Refer to the load ratings in the specifications above for details.
 - Install in accordance with all national and local electrical codes.
 - The range and performance of the wireless control system is highly dependent on the following: (1) distance between devices; (2) layout of the home; (3) walls separating devices; and (4) electrical equipment located near devices.
- 2 If installing in a multi-gang scenario, use pliers to remove the inner-side breakaway tabs. Bend each tab forward first, and then back and forth until it breaks off. Remove the inner-side tabs ONLY on any device side that will be adjacent to another device. DO NOT remove tabs on any side that will become the outer side of a group of devices. Handle the device with care after removing the tabs, as the broken edge can be sharp.

- 3 Turn off the local electrical power by either switching off the circuit breaker or removing the fuse from the fuse box. To ensure the wires do NOT have power running to them, use an inductive voltage detector.



NOTE: The back box wiring shown in this document is an example. Your wire colors and functions may differ. If you are not sure which wires are the Line In/Hot, Neutral, Load, Traveler, and Earth Ground wires, have a trained electrician perform the installation.

- 4 Prepare each wire. Wire insulation should be stripped back 5/8 of an inch from the wire end (see Figure 1).

Figure 1. Strip wire insulation

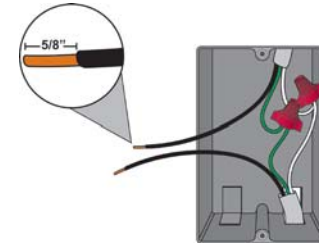

- 5 Identify your wiring application, and then see the appropriate wiring diagram in the "Sample Wiring Configurations" section below.



IMPORTANT! Not grounding this product, as described in the "Warnings and Considerations" section, may result in an installation less immune to damage caused by electrical disturbances, such as ESD or lightning, and may void the warranty.

- 6 Identify and connect the dimmer wires to the back box wires using the wire nuts.



IMPORTANT! The yellow wire is not a traditional traveler. It cannot directly power a lighting load. It must be used only to connect to a Control4 Auxiliary Keypad. See "Sample Wiring Configurations."



TIP: If you are using a Control4 push-on (screwless) faceplate in a multi-gang installation, attach the black faceplate subplate to all of the devices that will be installed into the back box prior to attaching the devices to the back box. This will help ensure that all the devices are properly aligned and on the same plane after installation.

- 7 Fit the wires back into the back box. Bend the wires in a zigzag pattern so that they easily fold into the back box (Figure 2).

Figure 2. Bend the wires

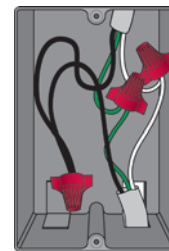

- 8 Align the dimmer to the back box (the load rating label should be at the bottom) and fasten it with screws. Tighten the screws until the back side of the yoke plate is even with the wall surface, but no further. Overtightening can warp the dimmer and cause mechanical malfunction.
- 9 Install the Control4 Faceplate following the instructions in the *Faceplate Installation Guide* or attach a standard Decora-style faceplate.
- 10 Attach the buttons, actuator bar, and sensor bar as described in the *Keypad Button Installation Guide*.

- 11 Turn ON power at the circuit breaker or replace the fuse from the fuse box.



Operation and configuration

On initial power up, all status LEDs on the dimmer will illuminate green indicating that the device has power. To set up this dimmer for use with a Control4 system, refer to the *Composer Pro User Guide*.

To operate this dimmer as a stand-alone device prior to configuration in Composer Pro:

- If the light is off, click any **button** to turn the light on.
- If the light is on, click any **button** to turn the light off.
- Press and hold any **button** to ramp the light up/down. Release the **button** at the desired light level.
- If the split up/down buttons have been installed in the bottom button slot, the up and down arrows will ramp and fade the light respectively.

Air gap switch

During routine lamp replacement, you should remove power from the lamp by engaging the air gap mechanism.

- 1 To engage, press on the right side of the top actuator bar until the left side pops out. All LEDs on the dimmer will turn off and the dimmer will no longer control the light when the air gap mechanism has been engaged.
- 2 To return power to the dimmer and lamp, press on the left side of the top actuator bar until it snaps back into place.

Figure 3. Dimmer with actuator bar

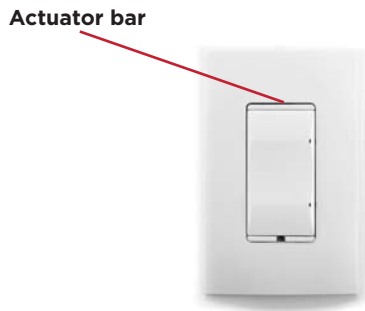

Button tap sequences

The button tap sequences are defined in the table below. Button tap sequences that require a single (1) button should use the top button. Button tap sequences requiring two (2) buttons should use the top-most and bottom-most buttons installed on the Keypad Dimmer.

Function	Button sequence
Identify	4
ZigBee channel	7
Reboot	15
Factory reset	9-4-9
Leave mesh and reset	13-4-13

Troubleshooting

If the light does not turn on:

- Ensure that at least one (1) LED on the face of the dimmer is lit.
- Ensure that the light bulb is not burned out and is screwed in tightly.
- Ensure that the circuit breaker is not turned OFF or tripped.
- Check for proper wiring (see "Sample Wiring Configurations").

- For help on the installation or operation of this product, email or call the Control4 Technical Support Center. Please provide your exact model number. Contact support@control4.com or see the web site www.control4.com.

Care and cleaning

- Do NOT paint the dimmer or its wall plate.
- Do NOT use any chemical cleaners to clean the dimmer.
- Clean surface of the dimmer with a soft damp cloth as needed.

Regulatory/Safety information

To review Regulatory information for your particular Control4 products, see the information located on the Control4 website at: <http://www.control4.com/regulatory/>.

Patent information

Applicable patents are available at <http://www.control4.com/legal/patents>.

Warranty

For complete warranty information, including details on consumer legal rights as well as warranty exclusions, review the Warranty card or visit www.control4.com/warranty.

About this document

Part Number: 200-00308 Rev F 6/18/2014 MS

Sample wiring configurations

Figure 4. Single device location, with neutral connection (recommended)

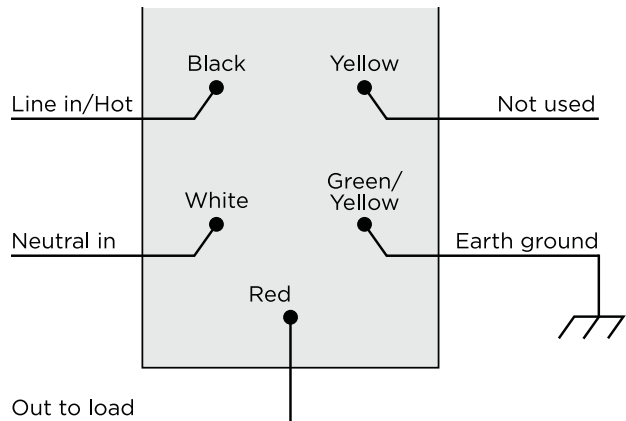

Figure 5. Single device location, without neutral connection

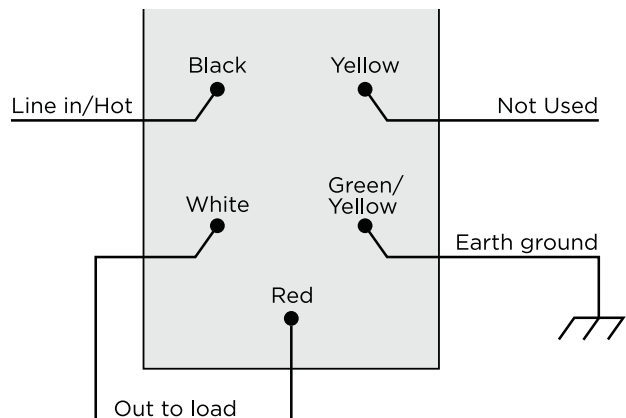

Figure 6. Multiple device location using Auxiliary Keypad, with neutral connection (recommended)

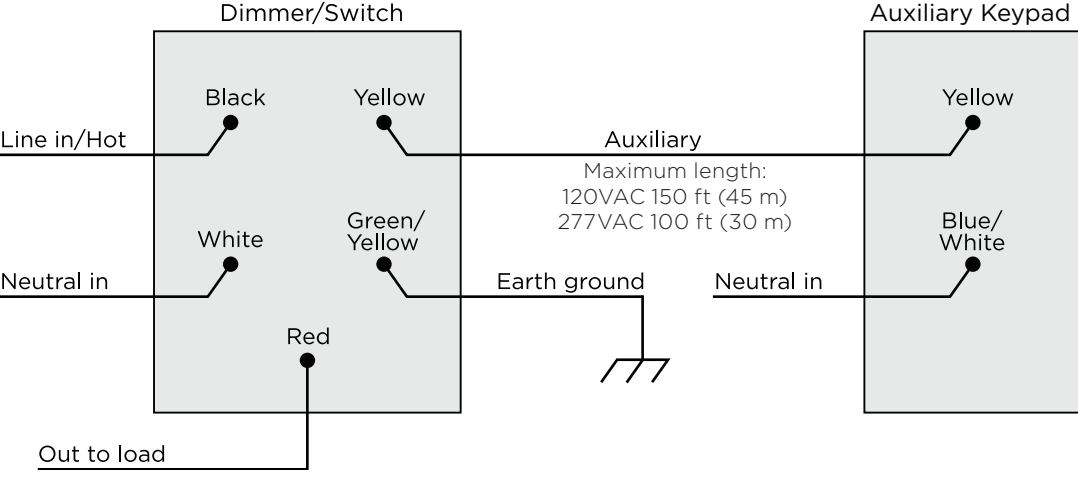
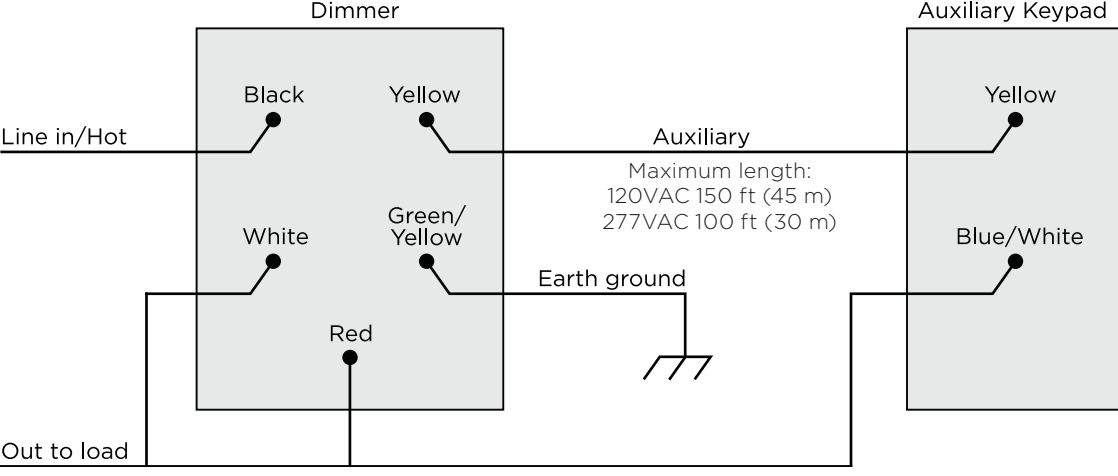

Figure 7. Multiple device location with Auxiliary Keypad, without neutral connection



IMPORTANT! When used in conjunction with an Auxiliary Keypad (C4-KA-xx), the wire connecting the Auxiliary Keypad to the dimmer must not exceed 150 feet (45 m) at 120VAC, and 100 feet (30 m) at 277VAC.

Figure 8. Multiple device location using Configurable Keypad, neutral required

